

— CORNER DETAIL
 SCALE: 6

SERIES 200 PROFILE

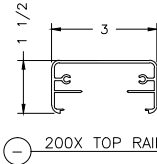

— 200X TOP RAIL

SERIES 300 PROFILE

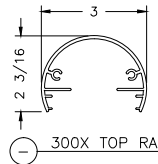

— 300X TOP RAIL

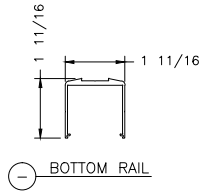

— BOTTOM RAIL

NOTE:
 SEE TOP RAIL PROFILE
 PAGE FOR ALL HANSEN
 TOP RAILS

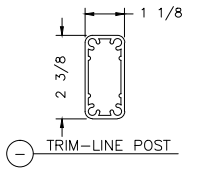

— TRIM-LINE POST

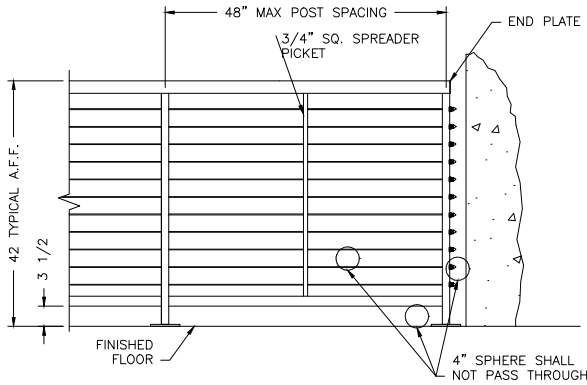

— TYPICAL ELEVATION

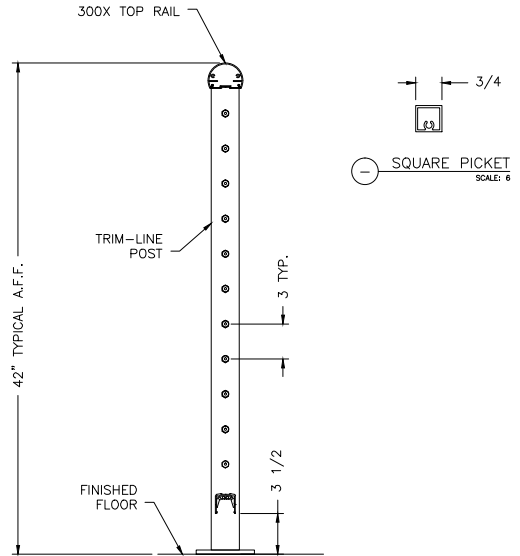

— TYPICAL SECTION
 SCALE: 2

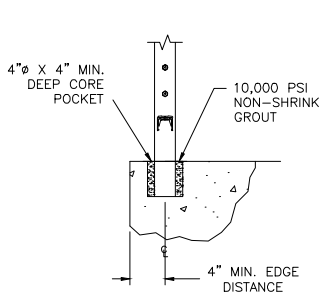

— CORE MOUNT

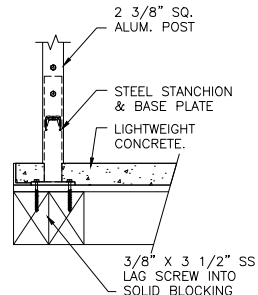

— STANCHION MOUNT

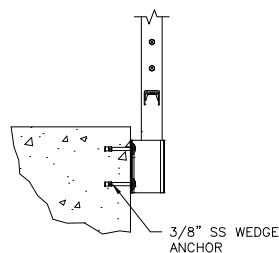

— FASCIA MOUNT

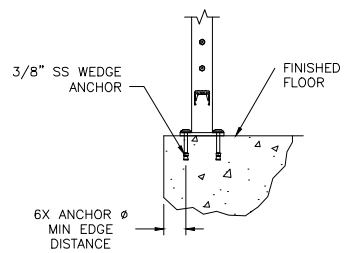

— SURFACE MOUNT